

vollara®
AIR & SURFACEPRO⁺

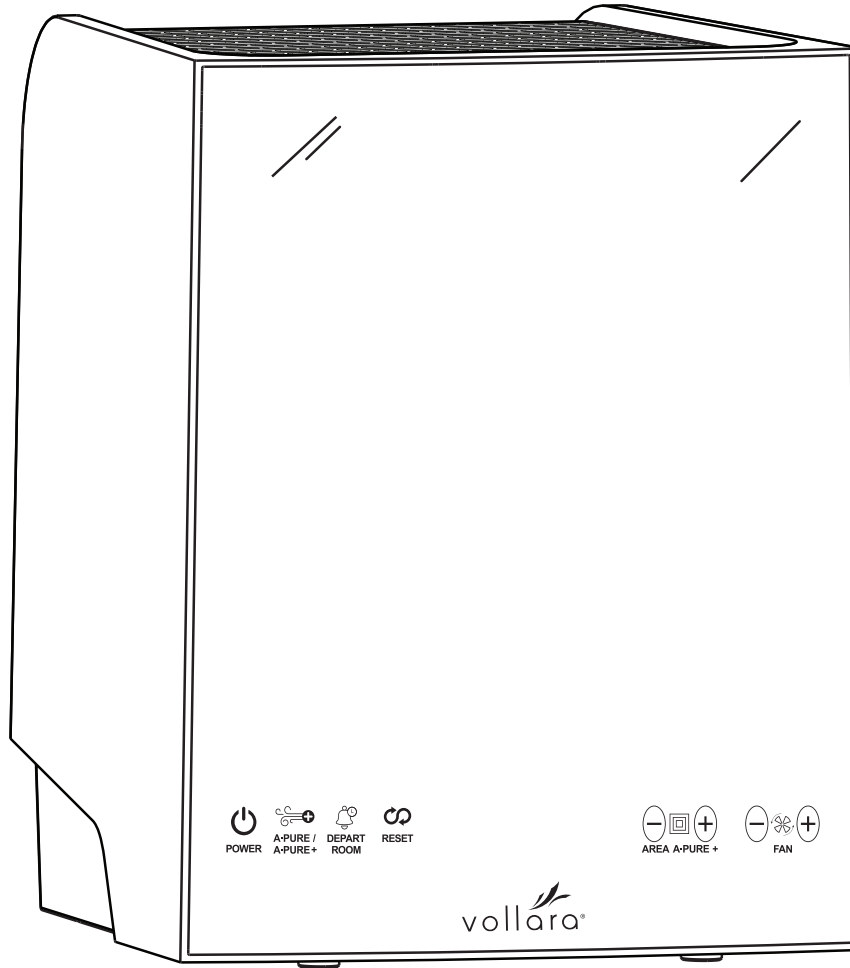

PORTABLE AIR PURIFICATION SYSTEM

READ MANUAL CAREFULLY FOR PROPER USE AND OPTIMAL OPERATION.



GENERAL INFORMATION

PRODUCT OVERVIEW

Congratulations on your purchase! Your new Vollara® Air & Surface Pro+ utilizes tested ActivePure Technology to provide 24/7 surface and air purification. Be sure to read and follow all service procedures outlined in this owner's manual, and use only genuine Vollara replacement parts.

CONTENTS

Product Overview	2
Specifications	2
Important Safety Instructions	3
Inspection & Installation	4
Unit Features	4
Operation	5
Settings & Adjustments	6
LED Display	7
Maintenance Reminders	7
General Maintenance.	8
Removing the Filter Assembly.	9
Uninstalling the Optional HEPA Filter Sheet	10
Removing the Purifier Plate & ActivePure® Cell	11
Installing the Purifier Plate & ActivePure® Cell	12
Troubleshooting	13
Replacement Parts & Service.	14
Warranty Information	15
FCC Declaration & Responsible Party	16

FILL IN AND SAVE

Record information regarding your new Vollara Air & Surface Pro+ here. Retain for future reference.

Model No. _____

Serial No. _____

Date of Purchase _____

Vollara Independent Distributor/Contractor:

Name _____

Phone No. _____

Address _____

SPECIFICATIONS

Vollara Air & Surface Pro+

- Model Number: A1041B
- Sales Number: 9940063

Technology:

- ActivePure® (1 Cell)
- Purification Plate • HEPA Filter Screen
- Activated Carbon Filter
- Carbon Brushes

Electrical:

- Input Voltage: 100 ~ 240 VAC; 50/60 Hz
- External power supply: DC 24 Volts; 1.5 Amps Max
- Power Consumption: 43 Watts Max
- Conforms to UL STD 867

Mechanical:

- Nominal Airflow Rate: 40-60 CFM Adjustable Speed Fan

Sound Level:

- 45 dB(A) on low; 55 dB(A) on high

Weight & Dimensions:

- 7.6 lbs (3.45 kg)
- 11.75" H x 9.5" W x 10" D
(29.8 cm x 24.1 cm x 25.4 cm)

Operating Temperature:

- 34°F – 100°F (1.6°C – 38°C)

Purification Plate Output (High Mode):

- > 2.0 ppm ozone

Recommended Maximum Coverage in a Contiguous Space¹:

- Up to 2,000 sq. ft. (185m²) depending on occupant density and other factors¹. High density commercial not to exceed 500 sq. ft. (46m²).

Warranty:

- Limited three (3) year warranty

Vollara, LLC reserves the right to change or modify any specification without notice.

1. Assumes 8 foot ceilings. Solutions should be customized based upon a variety of factors including HVAC system capabilities and settings, air flows taking into account walls, air pressure, and doors, ambient air temperatures and humidities, variable density, known VOC concentrations, and other layers of protection.

STORAGE AND DISPOSAL

Do not dispose of this product as household waste. Electrical waste and electronic products should be appropriately recycled as required by practices established by your local authority.



If you have any questions concerning this, or any Vollara product, contact your Vollara Independent Business Owner or Customer Service at 1.800.989.2299 or email customerservice@vollara.com

IMPORTANT SAFETY INSTRUCTIONS



CAUTION

- Allow your Vollara® Air & Surface Pro+ to warm to room temperature before operating; damage may result from turning on a cold unit
- Do not operate unit near heat sources, open flame, or combustible vapors or gases
- The Depart Mode feature of this unit is to be operated in unoccupied areas only. No people or pets should be in the area



WARNING

- Eye damage may result from directly viewing the light produced by the lamp used in this product; always turn off & unplug unit before removing filters or bulbs
- Do not operate this unit without the Filter Assembly and Back Cover installed
- Disconnect power cord before servicing
- When using electrical appliances, basic precautions should always be followed to reduce risk of fire, electric shock, and injury to persons, including the following:

Read this manual in its entirety before using your Vollara Air & Surface Pro+

Keep out of the reach of children.

- **NEVER** place your unit where it may fall into a bathtub or other water container; to protect against electrical hazards, **DO NOT** immerse in water or other liquids
- **DO NOT** touch the control panel or plug with a wet hands
- **DO NOT** run cord under carpeting; **DO NOT** cover cord with throw rugs, runners, or similar coverings; arrange cord away from traffic area and where it will not be tripped over
- **DO NOT** insert or allow foreign objects to enter any ventilation or exhaust opening as this may cause an electric shock or fire, or damage the air cleaner
- To prevent a possible fire, **DO NOT** block the air intakes or exhaust in any manner; **DO NOT** use on soft surfaces, like a bed, where openings may become blocked
- To avoid fire or shock hazard, plug the unit directly into an electrical outlet
- To disconnect the unit, turn controls to **OFF**, then remove plug from outlet; pull firmly on the plug, **DO NOT** unplug by pulling on the cord
- Always unplug the unit before moving or cleaning, or whenever the unit is not in use
- **DO NOT** use outdoors or on wet surfaces
- **DO NOT** attempt to repair or adjust any electrical or mechanical functions on this unit, doing so will void your warranty
- Connect to properly grounded outlets only
- To reduce the risk of electrical shock, do not change the plug in any way; **DO NOT** use adapters

SAVE THESE INSTRUCTIONS

INSPECTION & INSTALLATION

1. Remove protective packaging
2. Remove unit from shipping carton
3. Remove all protective materials
4. Check for shipping damage and loose or broken parts
5. Read Owner's Manual thoroughly prior to installation
6. Determine placement location for the unit (See "Operation" on page 5)
7. Insert the Power Supply Plug into the power receptacle on the rear of the unit.
Plug the appropriate cord into the Power Supply and into a working electrical outlet
8. Using the Power Button, turn the unit ON

UNIT FEATURES

- Exclusive ActivePure® Technology
- HEPA Filter Screen
- Activated Carbon Filter
- Multiple Carbon Brushes aid in the capture of contaminants
- Five Speed Fan
- LED Display
- Maintenance Reminders
- Replaceable ActivePure Cells
- Removable Rear Grill
- Universal Power Supply with Cords
- Adjustable Purifier Control (A·PURE+ only)
- Depart Room Mode w/Adjustable Digital Timer

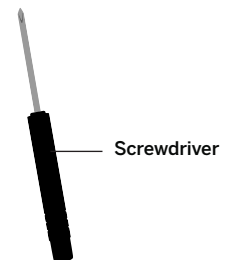
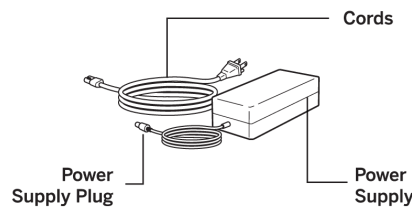
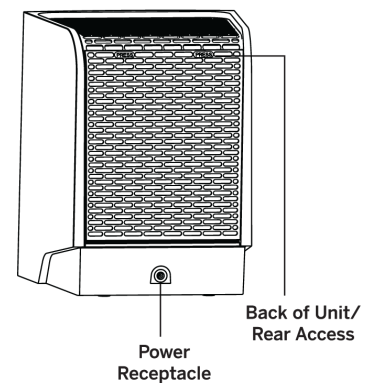
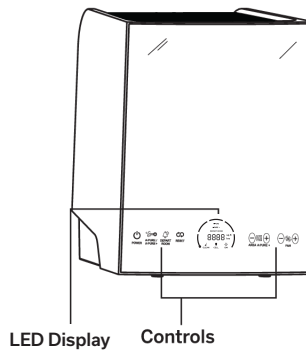

OPERATION



CAUTION

To prevent injury, be sure the power cord is not accessible to small children.

1. Take your Vollara® Air & Surface Pro+ unit out of the shipping carton and remove all protective materials.
 2. Place your unit in an appropriate location which should be four feet or higher from the ground. Never set it on the floor. Place in a location away from the HVAC return duct. The rear of the unit requires one inch or more of open area to allow unrestricted airflow.
 3. Insert the Power Supply Plug into the power receptacle on the rear of the unit. Plug the appropriate cord into the Power Supply and into a working electrical outlet.
 4. Push the Power button once to turn the unit on.
 5. Push the A·PURE/A·PURE+ button twice to set it to A·PURE+ level which will be illuminated on the screen.
 6. Push the Fan + button four times to reach the highest speed (5th level).
 7. To operate the DEPART ROOM feature, **in unoccupied areas only,*** press the DEPART ROOM button until the desired time is reached (2/4/8 hours). The unit will display DEPART ROOM and the remaining time. To interrupt the DEPART ROOM, press the A·PURE/A·PURE+ button.
- **A·PURE MODE:** The unit's display shows the fan speed (low to high) and A·PURE to indicate that the ActivePure® Cell and ionization are both functioning normally.
 - **A·PURE+ MODE:** A·PURE+ lights up, adjustable purifier coverage (500/1000/2000/3000) in square feet and fan speed (1/2/3/4/5).
 - **ION MODE:** Ion lights up, indicates only ionization is functioning.
 - **CLEAN:** Clean illuminates when cleaning is required.
 - **RESET:** Clears the maintenance reminders after performing routine maintenance.
 - **CELL:** The Cell light will flicker when it is time to replace your ActivePure® Cell.
 - **DEPART ROOM MODE:** The fan will show maximum, and DEPART ROOM will replace the purifier setting. The amount of time (2/4/8 hours) remaining will depend on how long you have selected for the DEPART ROOM Mode to operate, by pressing the Depart Room button

For best results, run your Vollara Air & Surface Pro+ 24 hours a day, 7 days a week, giving you the benefits of ActivePure day and night.

NOTE: "Unoccupied areas" includes pets. Some pets, like humans, may experience adverse reactions from exposure to increased levels of ozone and should not be present during DEPART ROOM MODE operation.

SETTINGS & ADJUSTMENTS

The Vollara Air & Surface Pro+ can be turned on or off, and adjusted, using the control panel on the front of the unit.

NOTE: If you are operating your central heating and air conditioning fan or other ventilation system continuously, set the coverage up to the total ventilated indoor area. Otherwise, set the coverage up to the size of the room. Do not exceed the size of the ventilated indoor area when setting the purifier level.

 **POWER (STAND BY)**
Turns the unit ON and OFF.

 **FAN UP/FAN DOWN**
Adjusts the five speed fan.

 **AREA A-PURE+**
Works when unit is in A-PURE + Mode to set the purifier level for the indoor area. The level is indicated by both a horizontal bar graph and square footage. The unit will switch to A-PURE Mode, if the Purifier DOWN button is pressed.

 **A-PURE/A-PURE+**
Toggles the unit between A-PURE Mode (ActivePure® and Ionization) and A-PURE+ Mode (1 ActivePure® Cell, Ionization, and Purification Plate).

 **REMINDER RESET**
Clears the maintenance reminders after performing routine maintenance.

 **DEPART ROOM**
Turns on and adjusts the timer for the Depart Room Mode. Each press of the Depart Room button will change the time by 2/4/8 hours, up to eight hours, then off. The Depart Room Mode should be operated in unoccupied areas only.

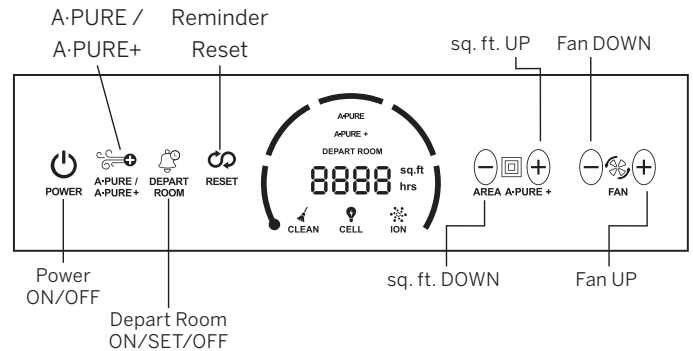

NOTE: “Unoccupied areas” includes pets. Some pets, like humans, may experience adverse reactions from exposure to increased levels of ozone and should not be present during DEPART ROOM MODE operation.

LED DISPLAY

The LED Screen is used to display all current settings (see page 5) as well as any maintenance reminders.

NOTE: If you are operating your central heating and air conditioning fan or other ventilation system continuously, set the coverage up to the total ventilated indoor area. Otherwise, set the coverage up to the size of the room. Do not exceed the size of the ventilated indoor area when setting the purifier level.

If a maintenance reminder or a service reminder appears, the backlight will brighten and constantly flash until the Reminder Reset icon is pressed or the service problem is corrected.

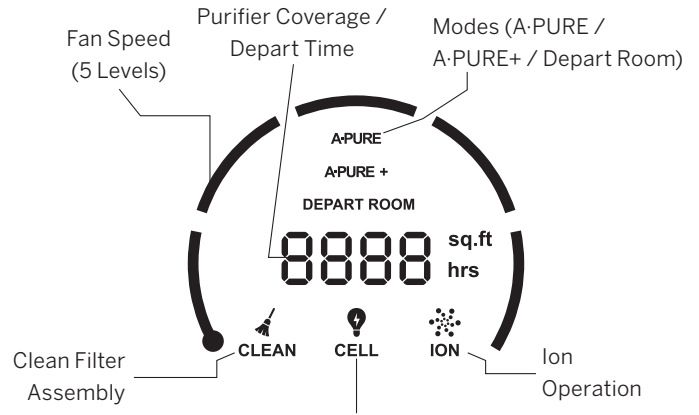

Flicker: Replace ActivePure® Cell
Red Light: ActivePure® Cell Malfunction

MAINTENANCE REMINDERS

When maintenance is required, the Display Screen will brighten and flash and the Maintenance Reminder will appear.



WARNING

Unplug the unit before performing any maintenance procedures.

Replace Plate

The Purifier Plate is not functioning properly.

- Replace the old Purifier Plate with a new Purifier Plate (available from your local Vollara Independent Business Owner)

PERFORM CLEANING

- The perform cleaning CLEAN indicator will come on approximately every 40 days; for optimal performance, it is recommended to perform cleaning on your unit every 30 days
- Clean the Filter Assembly (See Page 9)
- Vacuum the ActivePure Cell
- Clean the Purifier Plate (See Page 9)
- Vacuum Top and Rear Grill openings

NOTE: Be sure to press the Reminder Reset icon to clear the reminder following regular maintenance (see below)

When the CLEAN indicator starts flashing, it reminds you to clean the filter.

Follow the steps below to remove the filter and clean it. While powered on, hold the Reset button, approximately three seconds, until you hear a beep sound alerting you that it has been cleared.

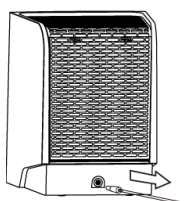

1. Unplug unit.

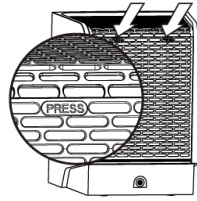

2. Press the top of the back cover to release the back panel.

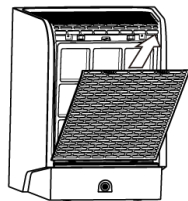

3. Lift up to remove the back panel.

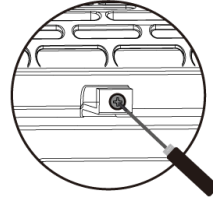

4. Use the included screwdriver to unscrew the Filter Assembly.

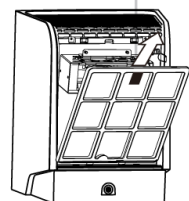

5. Lift the Filter Assembly up and out to remove.

MAINTENANCE REMINDERS (CONTINUED)



WARNING

Do not operate the Vollara® Air & Surface Pro+ without the Filter Assembly and Back Cover properly installed.



CELL

REPLACE ACTIVEPURE® CELL

The CELL indicator will light up if the ActivePure® Cell is no longer working. To order a new ActivePure Cell, contact your Independent Distributor/Contractor or Vollara Customer Service at 1.800.989.2299.

NOTE: The ActivePure Cell should be replaced every one (1) year, even if the unit does not display this message.

When the CELL indicator starts flashing, you will need to perform the following operations to reset:

- After 1 year of cumulative use, the CELL indicator starts flashing. After the user replaces the new ActivePure Cell according to the operation steps on page 11-12 of the manual, long press the RESET button for three seconds under the power off / standby state, you will hear a beep sound to let you know the reminder has been cleared.

When the CELL indicator starts flashing in red, you will need to perform the following operations to reset:

- The CELL indicator flashes in red to remind the user that ActivePure Cell is not properly installed. After disconnecting the power supply, reinstall ActivePure Cell and check whether the socket is installed properly. After the installation is successful, there is no need to press the RESET icon, the red light will automatically turn off. After the above operations, if the indicator remains flashing in red, ActivePure Cell is possibly damaged. In this case, contact your Independent Distributor/Contractor or Vollara Customer Service at 1.800.989.2299.

Resetting the Reminders

The reminders you need to reset are the PERFORM CLEANING and REPLACE ACTIVEPURE CELL indicators (after performing maintenance, press the Reset icon and the screen will stop flashing to let you know the reminder has been cleared, please see above instructions for each indicator).

GENERAL MAINTENANCE



WARNING

Unplug the unit before performing any maintenance procedures.



CAUTION

- Damage may result from soaking the Purifier Plate longer than 10 minutes
- Damage may result from using a Purifier Plate when not completely dry

Periodic maintenance is required to ensure that your Vollara Air & Surface Pro+ operates properly. The unit will display a PERFORM CLEANING reminder when it's time to perform regular maintenance. If you are operating your unit in a severely polluted environment, cleaning of the unit, Purifier Plate, ActivePure Cell, and Filter Assembly should be done more frequently. Shown here are basic procedures that should be carried out to keep your unit running at top performance.

For optimal performance, and to prevent damage not covered by your warranty, install the Optional HEPA Filter. Failure to perform routine maintenance could adversely affect the proper function of the unit or cause it to fail prematurely.

NOTE: If a unit is returned for repair, and it is determined that neglect of the unit or unauthorized tampering with any mechanical or electronic component of the unit caused the failure, Vollara reserves the right to void the product warranty. This will require the owner to pay for any required repairs.

Cleaning the Case

Wipe the unit with a soft cloth dampened (not wet) with water. Do not use chemicals or solvents. Vacuum the Top and Rear Grills periodically to remove any lint buildup.

GENERAL MAINTENANCE (CONTINUED)

Cleaning the ActivePure Cell

Remove the ActivePure® Cell and carefully vacuum accumulated lint. Do not wash the ActivePure Cell. Damage from water may result.

Filter Assembly Cleaning

1. When visibly dirty, simply remove the Rear Filter Assembly from the unit (See Page 9), and with a hand-held vacuum, remove the heavy particulate. This method will extend the life of the Filter Assembly.
2. If the Filter Assembly can't be cleaned by vacuuming, replace the Filter Assembly.

Filter Assembly Replacement

Contact your Independent Distributor/Contractor or Vollara® Customer Service at 1.800.989.2299 for replacement filters (see pages 9 – 10 for removal and installation instructions).

NOTE: Filter Assembly life will vary based on the operating environment.

Cleaning the Purifier Plate

Remove the Filter Assembly (see page 9). Carefully remove the Purifier Plate from the card cage by grasping the middle of the edge nearest to you, and slowly pull it straight out. If you are in an environment where there are fats, oils, or grease, such as in a kitchen, start by cleaning with denatured alcohol and a soft bristle brush. This will cut the grease without leaving a residue.

For all applications - Clean with a mixture of one part water and one part ammonia to remove contaminants. Place the plate into a shallow dish, and pour enough of the water/ ammonia solution into the dish to just cover plate. Allow the plate to soak for no more than 10 minutes.

Remove plate and scrub with a soft bristle brush. Rinse thoroughly. Let air-dry for 24 hours or use a blow dryer to dry thoroughly.

NOTE: Using a Purifier Plate that is NOT completely dry may damage the plate.

The unit will display a REPLACE PLATE message if the purification plate needs to be replaced.

Changing the ActivePure Cell

The ActivePure Cell should be replaced when REPLACE ACTIVEPURE CELL appears on the display, or twelve (12) months when used continuously. To change the ActivePure Cell, follow the instructions on pages 11-12.

REMOVING THE FILTER ASSEMBLY



WARNING

- Unplug the unit before performing any maintenance procedures
- Do not operate the Vollara Air & Surface Pro+ without the Filter Assembly and Back Cover properly installed

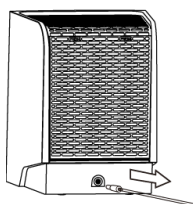

1. Unplug unit.

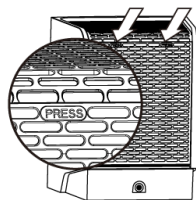

2. Press the top of the back cover to release the back panel.

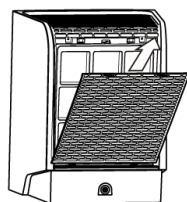

3. Lift up to remove the back panel.

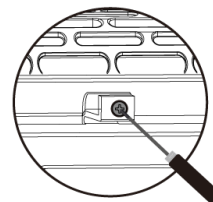

4. Use the included screwdriver to unscrew the Filter Assembly.

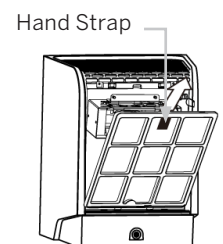

5. Lift the Filter Assembly up and out to remove.

UNINSTALLING THE OPTIONAL HEPA FILTER SHEET



WARNING

Unplug the unit before performing any maintenance procedures.

The Optional HEPA Filter Sheet is designed specifically for areas with tobacco smoke, multiple pets, or anywhere contaminants in the air could be prevalent.

- Protects your unit from indoor contaminants, which may shorten the life of your product
- Reduces monthly maintenance and cleaning time up to 90%
- Helps reduce odors
- Great in kitchen environments
- Helps reduce VOCs and other contaminants

NOTE: Removing the Optional HEPA Filter Sheet will increase the airflow of the unit.

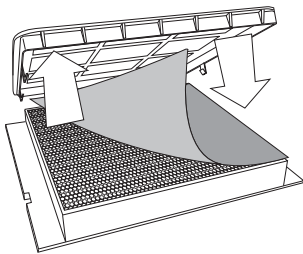

1. Remove the Filter Assembly (See Page 9).
2. Remove the Optional HEPA Filter Sheet on top of the Prefilter.

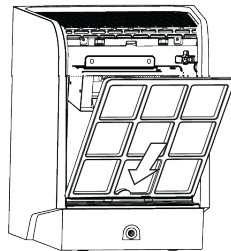

3. Replace the Filter Assembly, inserting the bottom of the Filter Assembly first.

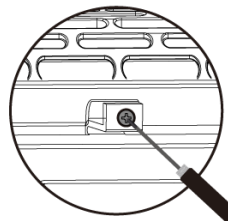

4. Use the included screwdriver to screw in the Filter Assembly.

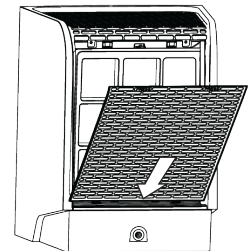

5. Replace the Filter Assembly, inserting the bottom of the Filter Assembly first.

REMOVING THE PURIFIER PLATE & ACTIVEPURE® CELL



CAUTION

Do not look directly at the glowing lamp. Prolonged exposure, even to reflected UV light, can cause eye damage according to the American Conference of Governmental Industrial Hygienists (ACGIH) Standards.



WARNING

- Unplug the unit before performing any maintenance procedures
- Do not operate the Vollara® Air & Surface Pro+ without the Filter Assembly and Back Cover properly installed

NOTE: Use genuine Vollara replacement parts only. Parts from anyone other than Vollara may damage your unit and void your warranty.

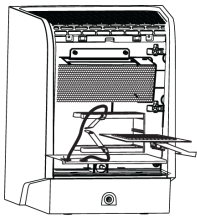

1. To remove the Purification Plate, grasp edge of plate in the center and gently pull out.

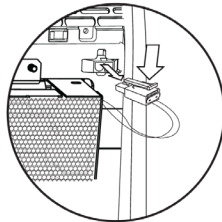

2. Unlock the ActivePure® Cell connector by pressing on the connector's locking tabs.

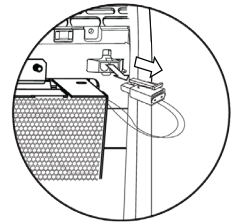

3. Pull the connector straight out to unplug.

NOTE: If the plate is difficult to remove, gently press down on the lower metal contact tab.

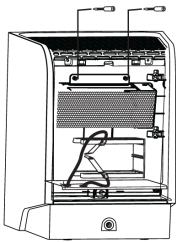

4. Remove two (2) thumbscrews.

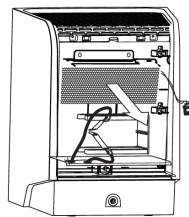

5. Slide the ActivePure® Cell down and out of unit.

INSTALLING THE PURIFIER PLATE & ACTIVEPURE® CELL



WARNING

- Unplug the unit before performing any maintenance procedures
- Do not operate the Vollara Air & Surface Pro+ without the Filter Assembly and Back Cover properly installed

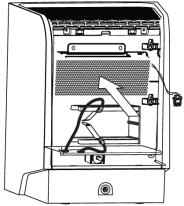

1. Slide the ActivePure Cell up and into the unit. Be sure the back lip of the ActivePure Cell engages the two slotted protrusions at the rear of the plate cage, and that the angle brackets and studs are correctly aligned.

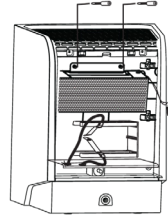

2. Insert the two thumbscrews and tighten. Insert the ActivePure® Cell connector into the plug on the plate cage.

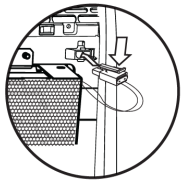

3. Press the connector firmly until the two tabs lock into place.



4. Gently insert the Purifier Plate between the guides (inside the cage) until it stops.

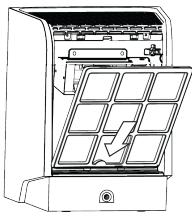

5. Replace the Filter Assembly, inserting the bottom of the Filter Assembly first.

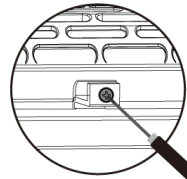

6. Use the included screwdriver to screw in the Filter Assembly.

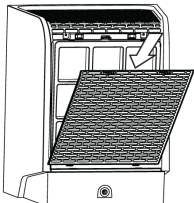

7. Replace the Back Cover by inserting the bottom in and snapping into place.

TROUBLESHOOTING

Indicators of Operation

When the unit is on, the LED display will show either the fan setting and A·PURE, or the fan setting, purifier setting, and square footage. If the unit is in Depart Room, it will display DEPART ROOM plus the hours and minutes remaining. See page 5 for more information.

Troubleshooting — What To Look For First

- 1. I have plugged in the unit, pressed the ON button on the Vollara® Air & Surface Pro+, and nothing happens. What's wrong?**
 - Make sure the power cord is inserted completely into the receptacle on the back of the unit
 - Make sure the electrical outlet is capable of providing power to the unit
- 2. The fan is operating but the Purifier Plate is not working. What's wrong?**
 - The unit is in A·PURE Mode (press the A·PURE/A·PURE+ switch to change to A·PURE+ Mode)
 - If the unit is displaying a REPLACE PLATE message, check the Purifier Plate for serviceability; if it is cracked or broken, the Purifier Plate will require replacement
 - Ensure maintenance procedures required for the Purifier Plate have been performed according to the "Maintenance" section of this Owner's Manual. Order new Purifier Plates from your Vollara Independent Business Owner.
- 3. The Purifier Plate is making a noise, has a burning smell, and/or appears to arc or spark. What is the problem?**
 - The Purifier Plate is most likely cracked; the unit will display a REPLACE PLATE message
 - Refer to the answers for question# 2, as it would apply to this question also
- 4. The UV Lamp is not functioning/I'm getting a "Replace ActivePure® Cell" Message.**
 - Check ActivePure® Cell for proper installation
 - Replace the ActivePure® Cell
- 5. What are the most typical application problems?**
 - *Symptom:* A belief that the proper equipment is placed in the environment and the equipment appears unsuccessful
 - *Problem:* Lack of air movement, improper placement of the unit
 - *Symptom:* Strong odors still remain within the environment after placement
 - *Problem:* Purifier setting is too low, improper placement of the unit, or the source of the odor has not been eliminated
 - *Symptom:* A strong odor of ozone is present within the environment
 - *Problem:* Too much ozone accumulation within the environment as a result of improper purifier control setting, and/or lack of air movement
 - *Symptom:* Visual haze of smoke and/or particulate remain within the environment
 - *Problem:* Lack of ionization and/or air movement
- 6. Air flow is restricted or reduced**
 - Is the unit properly placed away from objects that may obstruct air flow?
 - Are the Filter Assembly, Back Cover, and Top and Rear Grill clean?
 - Is the ActivePure® Cell clean?
- 7. How can I tell if the Active Pure® Cell is functioning?**
 - The ActivePure® Cell will produce a glow that is visible through the Top and Rear Grill under low light conditions
- 8. Unit does not operate.**
 - Is the unit plugged in?
 - Are you sure the outlet is active?
 - Are the Filter Assembly and Back Cover installed properly?

If your unit fails to operate properly after performing troubleshooting contact your independent Vollara Business Owner or Vollara Customer Service for further assistance at 1.800.989.2299 or email customerservice@vollara.com.

REPLACEMENT PARTS & SERVICE

REPLACEMENT PARTS (QTY)	PART NUMBER
ActivePure® Cell	9950240
Purification Plate (not available in California)	9950239
Filter Assembly	9950238
Power Supply with U.S./Euro Plug	9950242

To order replacement parts, contact your independent Vollara Business Owner or Vollara Customer Service for further assistance at 1.800.989.2299 or email customerservice@vollara.com.

WARRANTY INFORMATION

Limit Three (3) Year Warranty

To register your Vollara Air & Surface Pro+ unit, visit www.vollaraintl.com/vollara/warrantyregistration.aspx.

WHAT IS COVERED BY THIS WARRANTY

We warrant the Vollara Air & Surface Pro+ (excluding filters) to the consumer, subject to the conditions below, against defects in workmanship or material, provided that the products are returned to Vollara, LLC within the following time periods:

- Vollara Air & Surface Pro+ within three (3) years from date of purchase
- ActivePure Cell within one (1) year from date of purchase

MAINTENANCE REQUIREMENTS

This warranty is expressly conditioned upon proper, operation, cleaning and maintenance, all in accordance with the Owner's Manual. Failure to meet any of these requirements will void this warranty. Servicing of your Vollara Air & Surface Pro+ by parties other than our authorized representative and/or using parts other than genuine parts will also void this warranty. This warranty is contingent upon:

- Replacing the ActivePure Cell every (1) one year with a genuine ActivePure part (proof of change required)
- Cleaning the Filter Assembly every 30-40 days (according to instructions in Owner's Manual)
- Replacing the Filter Assembly every 6-12 months (proof of purchase required)

HOW TO OBTAIN WARRANTY SERVICE

Customer must contact Vollara Customer Service or go online to www.vollaraintl.com/vollara/warrantyregistration.aspx to activate their warranty within 6 months of purchase. We will repair or replace and return the product, without charge and within a reasonable period of time, subject to the conditions in the above paragraphs, if its examination shall disclose any part to be defective in workmanship or material. If we, in our discretion, are unable to repair the product after a reasonable number of attempts, we will provide either a refund of the purchase price or a replacement unit, at the company's option.

WHAT IS NOT COVERED BY THIS WARRANTY

Ordinary wear and tear shall not be considered a defect in workmanship or material. These warranties do not apply to filters nor for loss or damage caused by accident, fire, abuse, misuse, improper installation, modification, or misapplication.

MISSING SERIAL NUMBERS AND UNAUTHORIZED CHANNELS

If a valid serial number is missing from the product, the warranty will be voided. Warranties are voided if a product is purchased through unauthorized channels, this includes websites that are not authorized to sell our products OR to use Vollara trademarked names, images and logos as well as Internet auction sites (e.g. ebay and Craigslist). The only approved Internet presence for Vollara products is www.vollara.com. To confirm warranty coverage prior to purchasing a product, contact Vollara Customer Service at 1.800.989.2299 with the serial number located on the back of the unit.

EXCLUSION OF OTHER WARRANTIES AND CONDITIONS

EXCEPT AS PROVIDED HEREIN, AND TO THE EXTENT CONSISTENT WITH APPLICABLE LAWS, WE MAKE NO REPRESENTATION OR WARRANTY OF ANY KIND. ALL OTHER WARRANTIES OF ANY KIND, EXPRESS OR IMPLIED, ARE HEREBY EXPRESSLY DISCLAIMED, INCLUDING ANY IMPLIED WARRANTY OF MERCHANTABILITY OR FITNESS FOR A PARTICULAR PURPOSE.

LIMITATION OF LIABILITY FOR SPECIAL, INCIDENTAL, OR CONSEQUENTIAL DAMAGES

TO THE EXTENT CONSISTENT WITH APPLICABLE LAWS, WE SHALL NOT IN ANY CASE BE LIABLE FOR SPECIAL, INCIDENTAL OR CONSEQUENTIAL DAMAGES ARISING FROM BREACH OF EXPRESSED OR IMPLIED WARRANTIES, CONDITIONS, GUARANTEES OR REPRESENTATIONS, BREACH OF CONTRACT, NEGLIGENCE OR ANY OTHER LEGAL THEORY. Such excluded damages include, but are not limited to, loss of profits or revenue, and loss of the use of the products.

FOR U.S. APPLICATION ONLY

This warranty gives you specific legal rights, and you may also have other rights which vary from state to state. Some states do not allow limitations on warranties, or on remedies for breach. In such states, the above limitations may not apply to you.

FOR CANADIAN APPLICATION ONLY

Exclusion of Subsequent Owners: Except as otherwise required by applicable legislation, this warranty is not transferable. This warranty gives you specific legal rights and you may also have other rights which vary from province to province. Some provinces and territories do not allow limitations on warranties, or on remedies for breach. In such provinces or territories, the above limitations may not apply to you. If any provision of this warranty or part thereof is held by a court of competent jurisdiction to be invalid, illegal, or unenforceable, the validity, legality and enforceability of the remaining provisions or parts thereof will not in any way be affected or impaired within the jurisdiction of that court. This entire warranty shall continue to be valid, legal and enforceable in any jurisdiction where a similar determination has not been made.

This warranty is provided by:
Vollara, LLC
1300 Valley Drive
Bristol, VA 24201

SERVICE

Every effort is made to ensure customers receive an up-to-date instructions manual on the use of our products; however, from time to time, modifications to our products may without notice make the information contained herein subject to alteration. For the latest information, please visit our website at www.vollara.com/manuals.

FCC DECLARATION & RESPONSIBLE PARTY

This equipment has been tested and found to comply with the limits for a Class B digital device, pursuant of part 15 of the FCC Rules. These limits are designed to provide reasonable protection against harmful interference in a residential installation. This equipment generates, uses, and can radiate radio frequency energy, and if not installed and used in accordance with the instructions, may cause harmful interference to radio communications. However, there is no guarantee that interference will not occur in a particular installation. If this equipment does cause harmful interference to radio or television, which can be determined by turning the equipment off and on, the user is encouraged to try to correct the interference by one or more of the following measures:

- Reorient or relocate the receiving antenna.
- Increase the separation between the equipment and receiver.
- Connect the equipment into an outlet on a circuit different from that to which the receiver is connected.
- Consult the Independent Contractor for help.

FCC DECLARATION OF CONFORMITY

Name: Vollara® Air & Surface Pro+

Model: A1041B

Manufactured For: Vollara, LLC

This device complies with Part 15 of the FCC Rules.

RESPONSIBLE PARTY

Vollara, LLC
1300 Valley Drive
Bristol, VA 24201

Ph: 1.800.572.0502

Signature: 

Printed Name: Andrew Eide

Title: Vice President of Product Development
and Manufacturing

Date: 07/14/22



For information regarding the use of this product please contact your
Vollara Independent Business Owner or Customer Service at **1.800.989.2299**
or email **customerservice@vollara.com**.

www.vollara.com